

**GERSTEL**

AppNote 9/2012

Solid Phase Micro-Extraction (SPME) Coupled with Selectable ¹D/²D GC-MS for the Determination of Food Product Flavors

John R. Stuff, Jackie A. Whitecavage
*Gerstel, Inc., 701 Digital Dr. Suite J,
Linthicum, MD 21090, USA*

KEYWORDS

Selectable ¹D/²D GC-MS, SPME, food, flavor, fragrance

ABSTRACT

Identification of important trace components in complex samples like fragrances, natural products, polymers or food products can be challenging. Achieving the mass on column and resolution necessary to locate peaks and identify trace components using a single column chromatographic separation can be difficult, if not impossible.

A selectable ¹D/²D GC-MS configuration based on Agilent® Technologies capillary flow technology (CFT) and low thermal mass (LTM) GC column modules with dissimilar column phases was used to perform two-dimensional GC analysis of different foodstuffs. Heartcutting was used to transfer analytes from the first to the second column. Mass spectrometry and olfactory detection were performed in parallel. Solid Phase Micro-Extraction was used as a solventless means to introduce sufficient mass of sample onto the precolumn of the multi-dimensional system. SPME offers the added benefit of enabling “tuning” of the selectivity of the extraction through the choice of coating on the fiber.

Separation and identification of selected flavor compounds from food products were used to demonstrate the effectiveness of the system. The main advantages of this configuration were the simple selection of one or two dimensional operation in combination with the ability to use mass spectrometry and olfactory detection in both dimensions for the analysis of odor active compounds.

INTRODUCTION

Two dimensional gas chromatography using heartcutting is an effective tool for resolving compounds in a complex matrix. Typical systems use a non-selective detector, such as an FID, in the first dimension and a selective detector, such as an MSD, in the second. The system described in this work uses capillary flow technology (CFT) hardware from Agilent Technologies to enable parallel mass spectrometry and olfactory detection for both the first and second dimension separation. The system requires no hardware changes for operation in either one- or two dimensional mode. The effectiveness of the system is demonstrated in this study using potato chips and spices as examples.

EXPERIMENTAL

Instrumentation. Analyses were performed on a 6890 equipped with a 5975C inert XL MSD with triple axis detector and LTM Columns (Agilent Technologies), PTV inlet (CIS 4, GERSTEL), MPS 2 Sampler with SPME Option (GERSTEL), and an Olfactory Detection Port ODP 2 (GERSTEL).

Analysis conditions.

MPS: SPME (DVB-Carboxen-PDMS)
CIS 4: SPME liner
split, 10:1
250°C (isothermal)
Pneumatics: constant pressure
Oven: 250°C, held for duration
1st Column: 30 m Rtx-5Sil MS (Restek),
LTM format
 $d_i = 0.25 \text{ mm}$ $d_f = 0.25 \text{ }\mu\text{m}$
40°C (1 min); 10°C/min; 160°C;
140°C/min; 300°C (3 min)
2nd Column: 30 m DB-Wax (Agilent), LTM format
 $d_i = 0.25 \text{ mm}$ $d_f = 0.5 \text{ }\mu\text{m}$
40°C (17 min); 10°C/min; 210°C;
170°C/min; 40°C
MSD: full scan, 40-350 amu
MSD/ODP: 1/1 split

Sample preparation. Potato chips and spice samples were purchased at a local grocery store. The potato chip samples were crushed. A 3.0 gram sample was placed in a 20 mL screw capped vial. The spice samples, approximately 0.25 grams, were placed directly in a 20 mL screw cap vial.

Sample introduction. The samples were placed in a VT-32, 32-position tray on the MPS autosampler. The samples were equilibrated at 65°C for 3 minutes at an agitation speed of 250 rpm, and the headspace above the sample extracted for 20 minutes using an SPME fiber. The SPME fiber was subsequently introduced into the CIS 4 and desorbed at 250°C for three minutes at a 5:1 split ratio.

RESULTS AND DISCUSSION

A diagram of the selectable ¹D/²D GC-MS system configuration is shown in Figure 1. Details of the setup have been described elsewhere. [1,2]

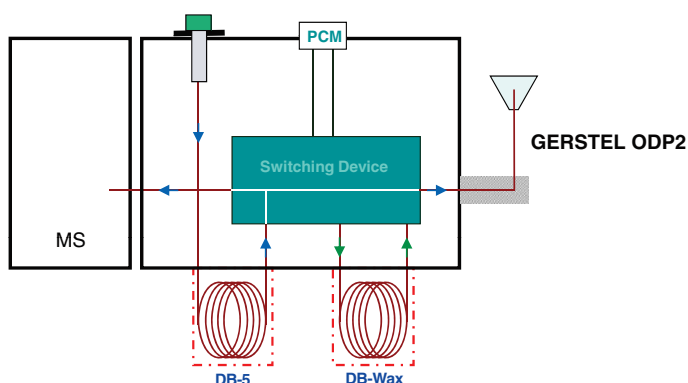

Figure 1. Diagram of Selectable ¹D/²D GC-MS setup.

The first example shows the determination of volatile compounds in the headspace inside a potato chip bag based on a single dimension separation. A bag of chips was placed on the dashboard of a car for four hours. The car was parked in the sun to accelerate the degradation of the product. When the bag was opened, a distinct rancid odor was detected. Figure 2 shows a comparison of the chromatograms obtained from fresh and rancid chips. The compounds responsible for the rancid odor, mostly aldehydes, are easily seen. Figure 3 shows a comparison of two different brands of chips. Brand Y shows a higher level of acetone and hexanal, indicating that these chips are less fresh.

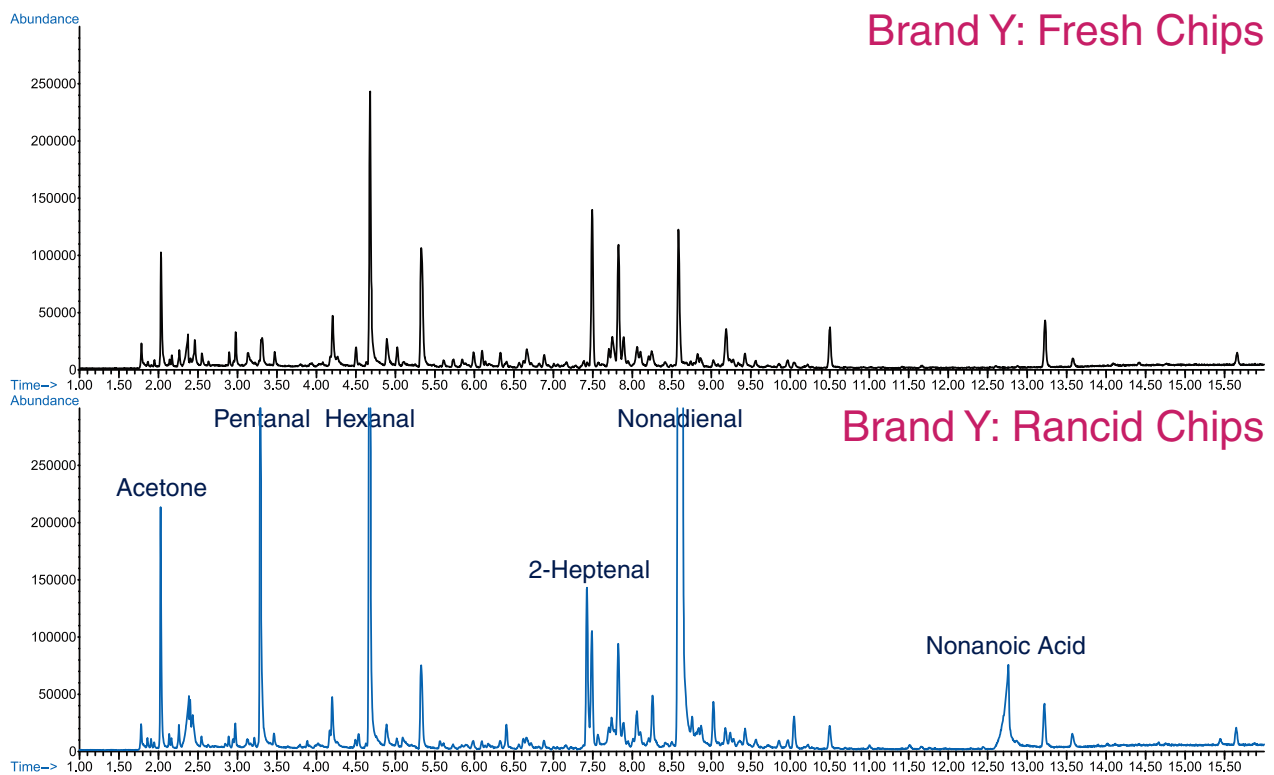

Figure 2. Total ion chromatograms obtained from fresh and rancid chips.

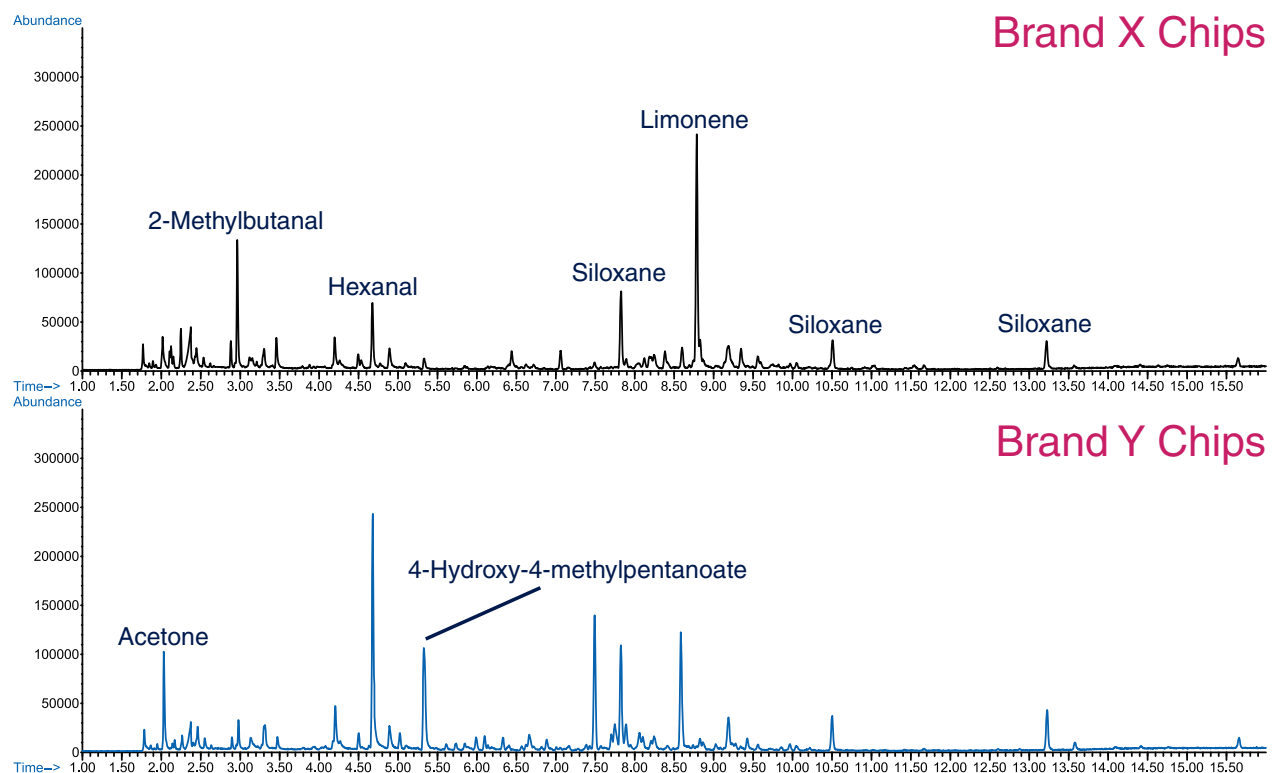

Figure 3. Total ion chromatograms obtained from two potato chip brands.

Figure 4 shows a comparison of plain and flavored chips from the same manufacturer. The compounds associated with the individual flavors are easily seen. The sour cream and green onion flavor chromatogram shows some methoxy-propoxypropanols which may stem from the packaging material. The salt and vinegar flavor chips exhibit a large acetic acid peak, and the barbecue chips show a very complex chromatogram with a wide range of terpenes. Olfactory detection combined with automated voice recognition and text conversion was performed on this sample. The result was a rather confusing list of descriptors from overlapping peaks in the chromatogram. The section of the chromatogram from 6.5-10.5 minutes, was then heart-cut and transferred to

the second column for further separation. The first dimension column was backflushed starting at 10.6 minutes. The resulting chromatogram is shown in Figure 5.

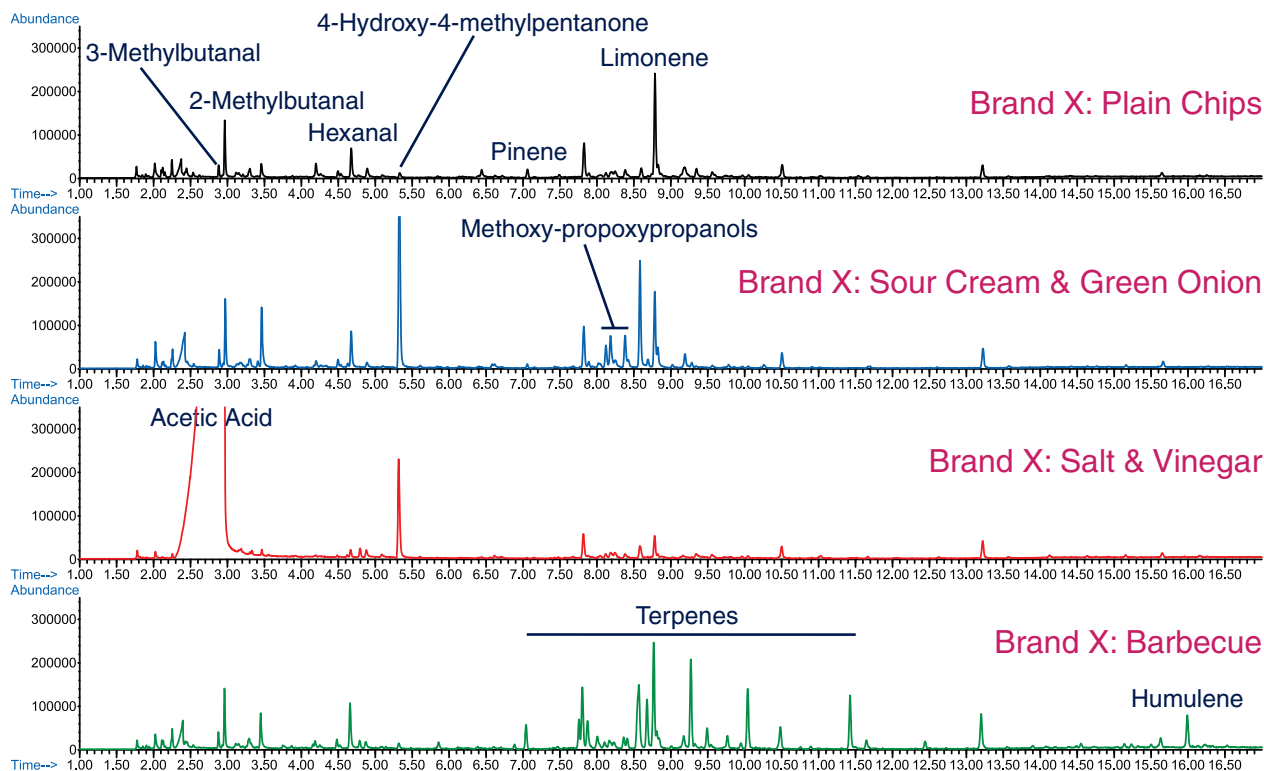

Figure 4. Stacked view of total ion chromatograms for plain and flavored chips.

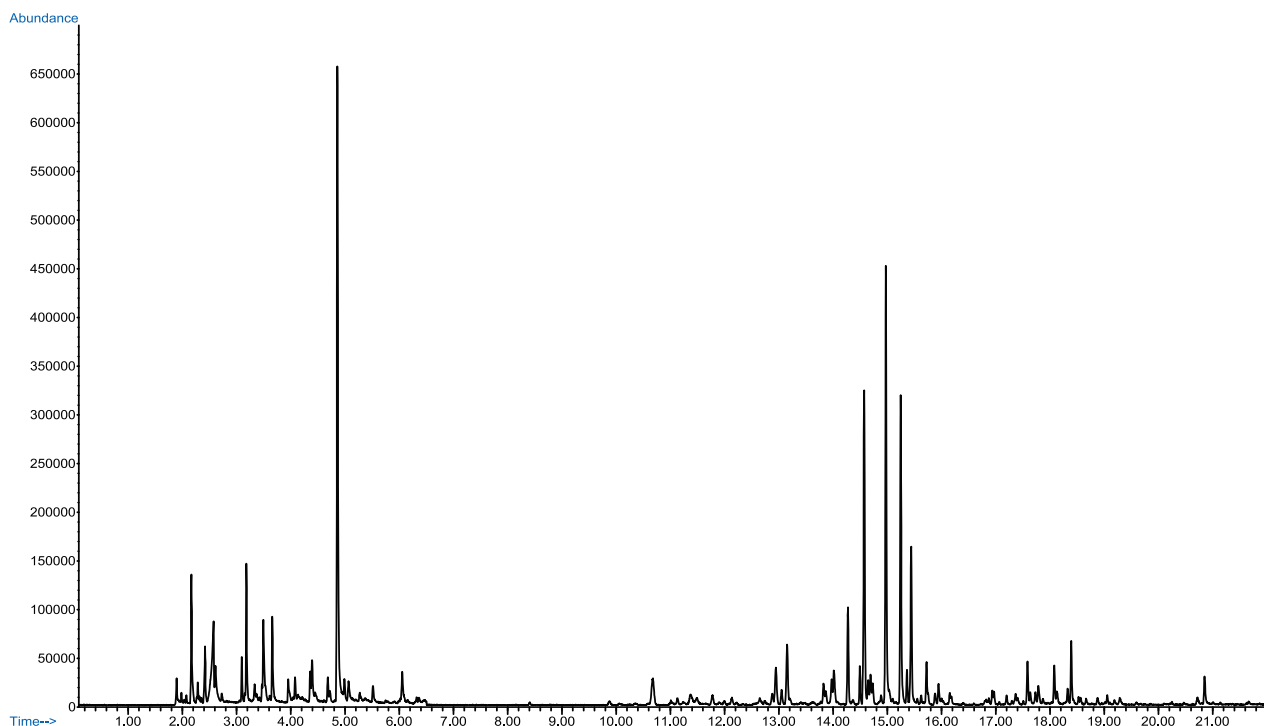

Figure 5. Combined ¹D and ²D chromatogram obtained from barbecue flavored chips.

As can be seen, additional compounds are separated in the second dimension enabling their identification along with a description of their olfactory qualities. Olfactory detection of the compounds separated in the 2nd dimension was used to identify important pyrazines, which are formed during the cooking process and which contribute to the fried potato flavor [3]. Figure 6 shows an enlarged view of the region from 15.5-19.5 minutes. Table 1 list the identities, descriptors and literature aroma profile for the compounds labeled in Figure 6.

Table 1. Peak identities for Figure 6.

	Compound	Descriptor	Aroma profile
1	Dimethylpyrazine isomer	Burnt	Nutty, roasted
2	Dimethylpyrazine isomer	Burnt	Nutty, roasted
3	Ethyl methylpyrazine	Barbecue	Potato, hazelnut, coffee
4	Trimethylpyrazine	Burnt Potato	Roasted, baked potato
5	Dimethyl ethylpyrazine	Potato	None found

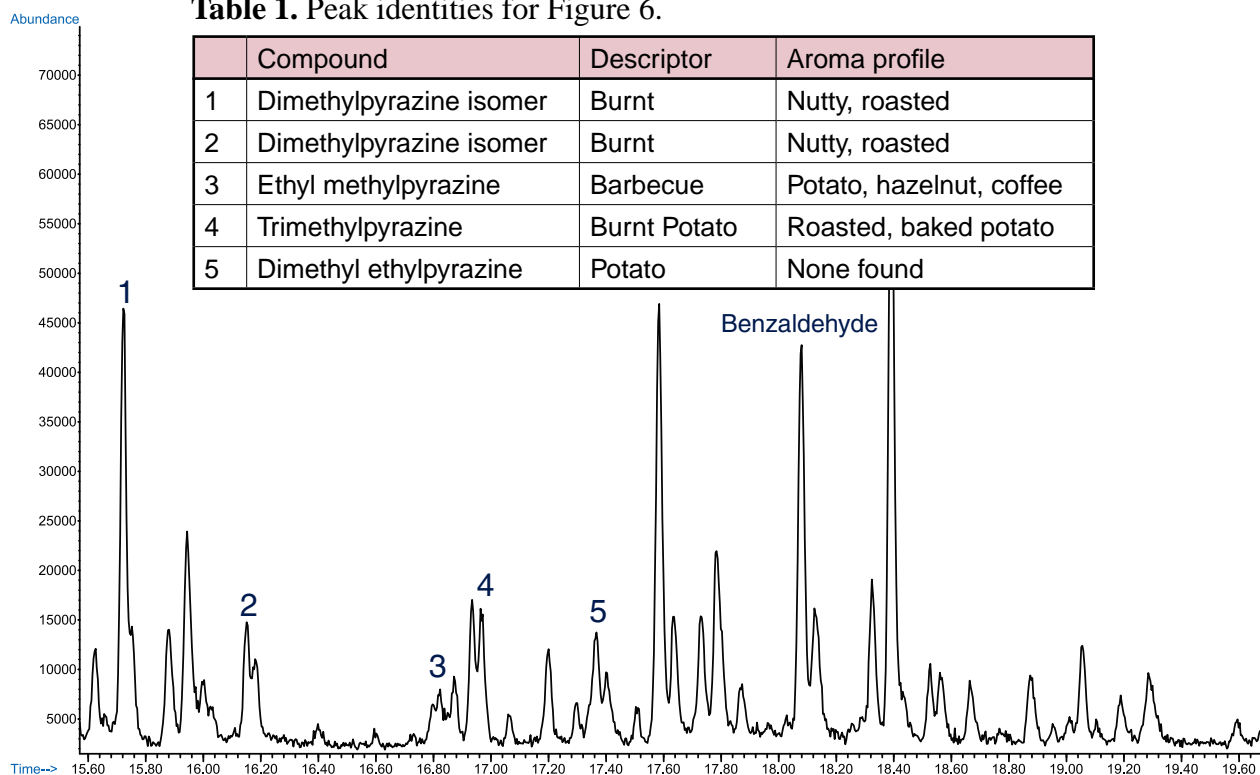

Figure 6. Enlarged view of a section of the chromatogram obtained from barbecue flavored chips.

The second example shows the SPME headspace analysis of a poultry seasoning. The seasoning declaration of ingredients listed thyme, sage, marjoram, rosemary, black pepper, and nutmeg. Figure 7 shows the ¹D chromatogram from the headspace SPME extraction of the poultry seasoning. Overlapping peaks on the front of the cubebene peak were cut over to the 2nd dimension for further separation and identification. Figure 8, shows the resulting ²D chromatogram.

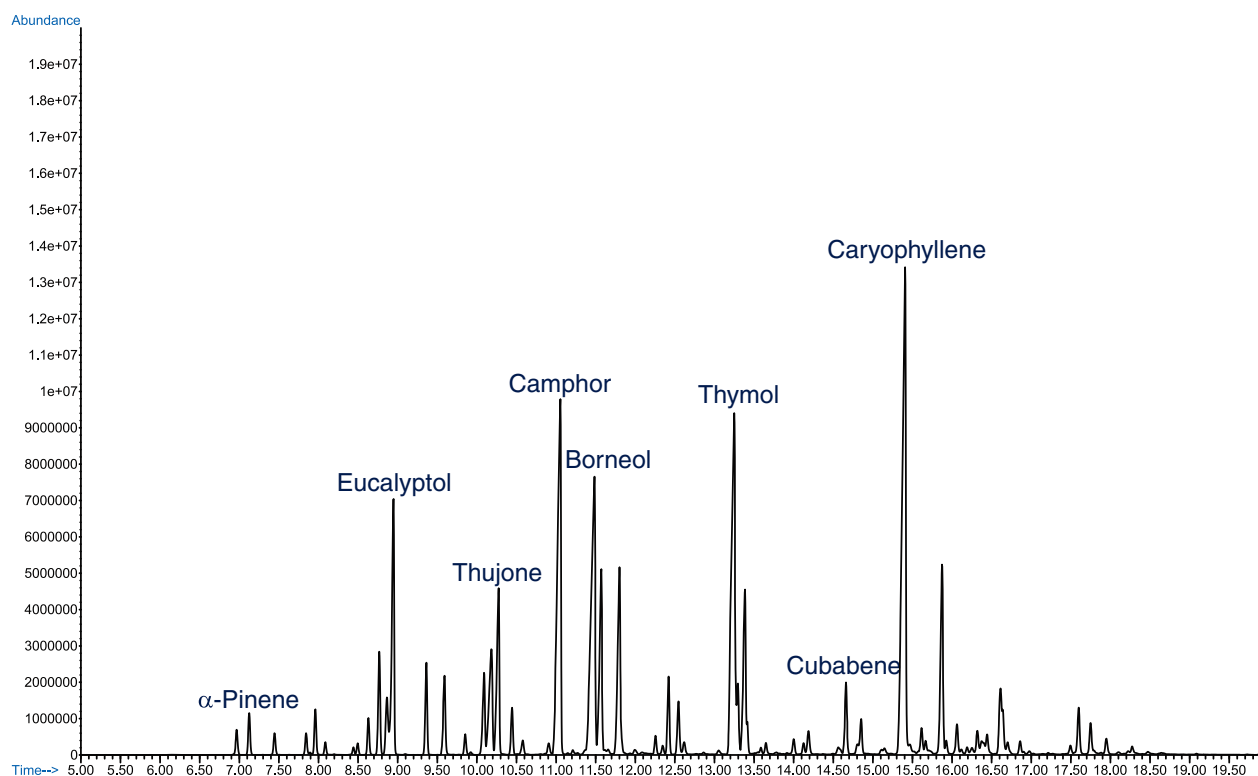

Figure 7. Total ion chromatogram obtained from poultry seasoning.

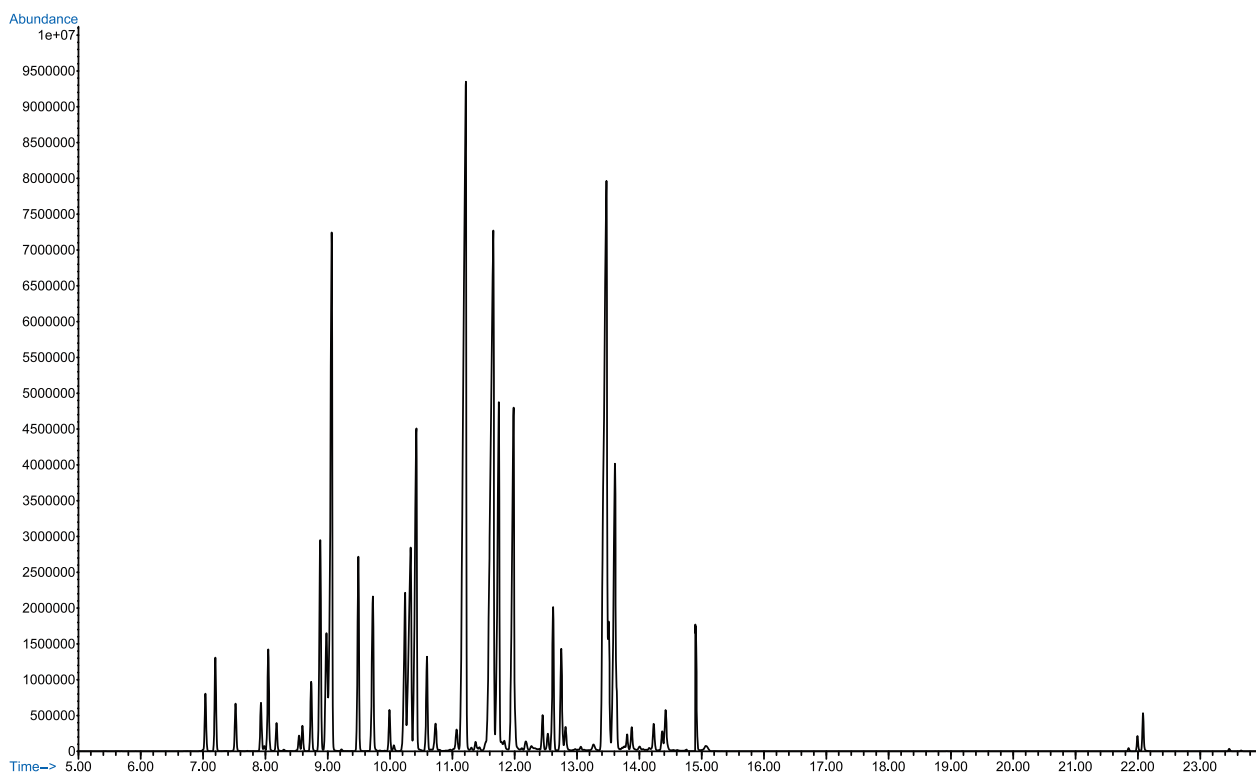

Figure 8. Combined ¹D and ²D chromatogram obtained from poultry seasoning.

Figure 9 shows an enlarged view of the area from 20-22 minutes. Two peaks with floral notes, isledene and ylangene, are well resolved from the cubebene (woody note). The figure also shows the overlay of three separate runs demonstrating the good reproducibility of the system. Only a small portion of the cubebene peak from the first dimension was cut and transferred to the ²D column, so one would not expect good precision for this peak in the second dimension.

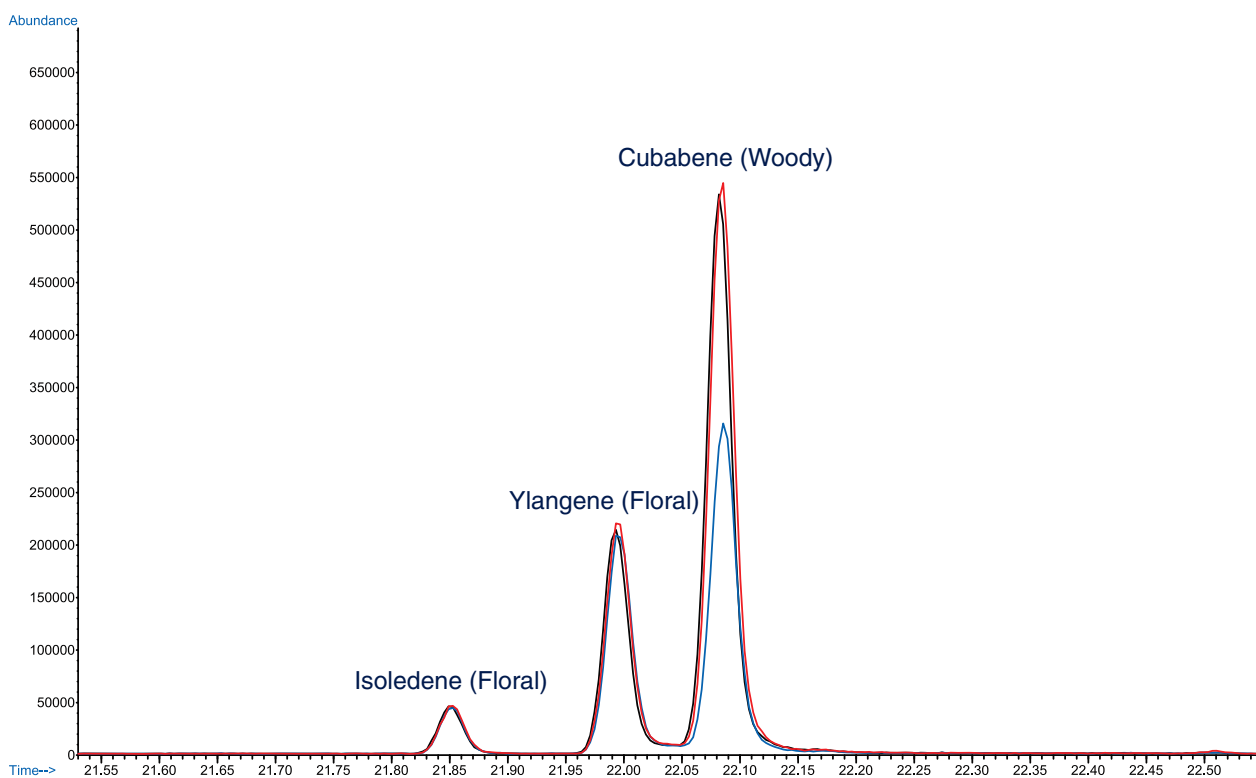

Figure 9. Enlarged stacked view of three chromatograms obtained from poultry seasoning.

Stereochemistry can also be an important factor in the odor profile of a compound. The last example shows the use of a chiral column in the second dimension to separate isomers. A standard of 3,3,5-trimethyl-2-cyclohexen-1-ol was introduced into the GC using SPME. Figure 10 shows the ¹D and ²D chromatograms for this sample. In the first dimension, a single peak is seen with a flavor descriptor of “spicy”. When the peak is cut over to the 2nd dimension, four peaks are seen. The first major peak is the isomer responsible for the flavor (spicy, tobacco). None of the other isomers resulted in a perceptible olfactory impression at the ODP.

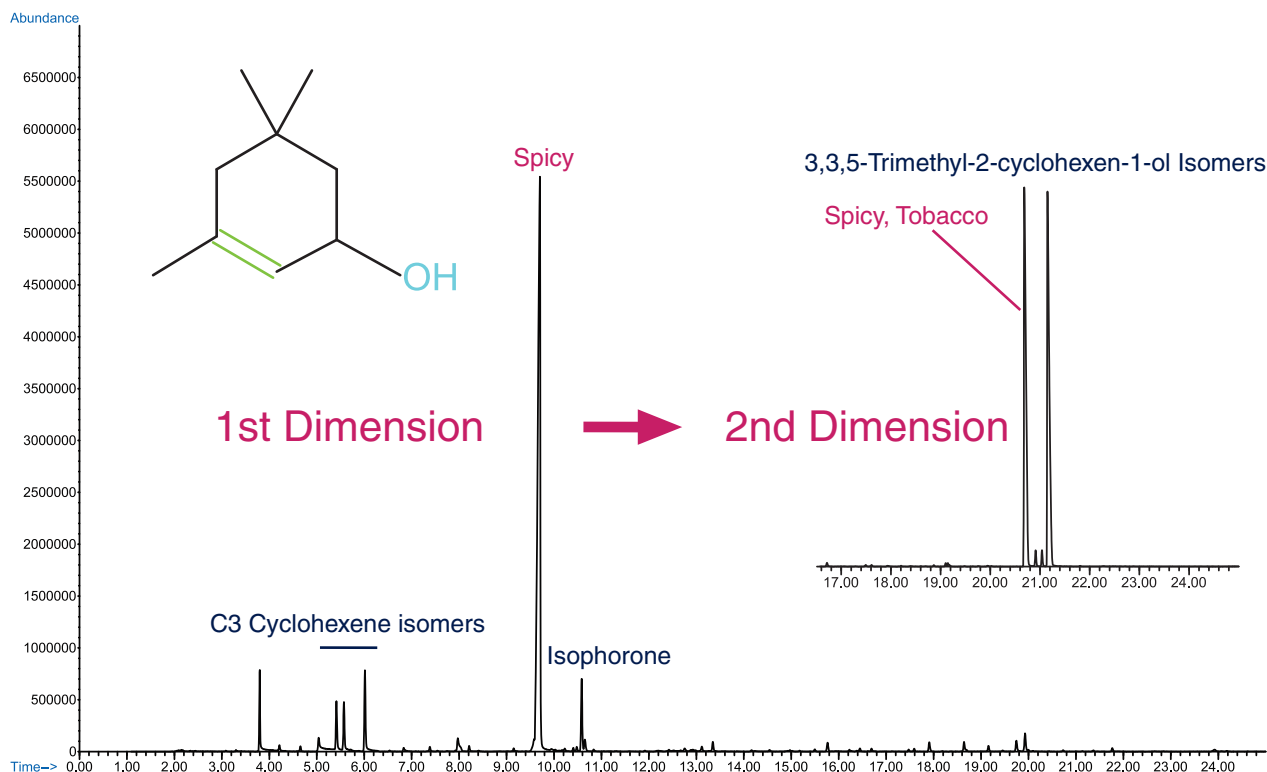

Figure 10. Comparison of ¹D and ²D chiral separation for 3,3,5-trimethyl-2-cyclohexen-1-ol.

CONCLUSIONS

The selectable ¹D/²D GC-MS system with a valveless flow switching device is a powerful system for the analysis of trace components in complex samples. The main features of this configuration are the simple selection of one- or two dimensional operation. The setup of the system is facilitated through the use of GERSTEL ¹D/²D Sync software, which calculates critical method parameters for the selected column set.

REFERENCES

- [1] N. Ochiai and K. Sasimoto, *J.Chrom.A*, 1217, 2903-2910 (2010)
- [2] N. Ochiai and K. Sasimoto, *J.Chrom.A*, 1218, 3180-3185 (2011)
- [3] R.G. Buttery, R.M. Siefert, D.G. Guadagni, and L.C. Ling, *J. Agric. Food Chem.*, 19(5), 969-971 (1971)



GERSTEL GmbH & Co. KG

Eberhard-Gerstel-Platz 1
45473 Mülheim an der Ruhr
Germany

+49 (0) 208 - 7 65 03-0
+49 (0) 208 - 7 65 03 33
gerstel@gerstel.com
www.gerstel.com

GERSTEL Worldwide

GERSTEL, Inc.

701 Digital Drive, Suite J
Linthicum, MD 21090
USA

+1 (410) 247 5885
+1 (410) 247 5887
sales@gerstelus.com
www.gerstelus.com

GERSTEL AG

Wassergrabe 27
CH-6210 Sursee
Switzerland

+41 (41) 9 21 97 23
+41 (41) 9 21 97 25
swiss@ch.gerstel.com
www.gerstel.ch

GERSTEL K.K.

1-3-1 Nakane, Meguro-ku
Tokyo 152-0031
SMBC Toritsu-dai Ekimae Bldg 4F
Japan

+81 3 5731 5321
+81 3 5731 5322
info@gerstel.co.jp
www.gerstel.co.jp

GERSTEL LLP

10 Science Park Road
#02-18 The Alpha
Singapore 117684

+65 6779 0933
+65 6779 0938
SEA@gerstel.com
www.gerstel.com

GERSTEL (Shanghai) Co. Ltd

Room 206, 2F, Bldg.56
No.1000, Jinhai Road,
Pudong District

Shanghai 201206
+86 21 50 93 30 57
china@gerstel.com
www.gerstel.cn

GERSTEL Brasil

Av. Pascoal da Rocha Falcão, 367
04785-000 São Paulo - SP Brasil

+55 (11)5665-8931
+55 (11)5666-9084
gerstel-brasil@gerstel.com
www.gerstel.com.br

Information, descriptions and specifications in this
Publication are subject to change without notice.
GERSTEL, GRAPHPACK and TWISTER are registered
trademarks of GERSTEL GmbH & Co. KG.

© Copyright by GERSTEL GmbH & Co. KG



Awarded for the
active pursuit of
environmental sustainability